

General Purpose Silicon Rectifiers

1N4001FH ~ 1N4007FH

■ Features

- Surface Mount General Purpose Silicon Rectifiers
- Reverse Voltage - 50 to 1000 V
- Forward Current: 1 A

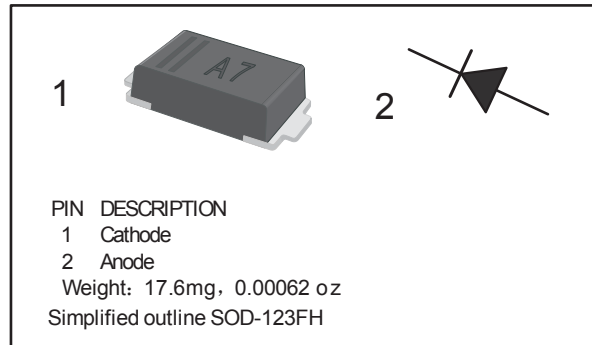

■ Absolute Maximum Ratings Ta = 25°C

Parameter	Symbol	1N4001FH	1N4002FH	1N4003FH	1N4004FH	1N4005FH	1N4006FH	1N4007FH	Unit	
Repetitive Peak reverse voltage	VRRM	50	100	200	400	600	800	1000	V	
Surge Peak reverse voltage	VRSM	35	70	140	280	420	560	700		
Maximum DC Blocking Voltage	VDC	50	100	200	400	600	800	1000		
Forward voltage @IF=1A	VF	1.1								A
Max.averaged fwd.current. @Ta=65°C	IFAV	1								
Peak forward surge current	IFSM	25								μA
Maximum DC Reverse Current Ta=25°C	IR	5								
Ta=125°C		100								
Typical Junction Capacitance *1	Cj	4								pF
Thermal Resistance Junction to Ambient*2	RθJA	180								°C/W
Junction temperature	Tj	150								°C
Storage temperature	Tstg	-55 to 150								

* 1 Measured at 1 MHz and applied reverse voltage of 4 V D.C

* 2 Thermal resistance from junction to ambient at 0.375" (9.5 mm) lead length, P.C.B. mounted

■ Marking

NO.	1N4001FH	1N4002FH	1N4003FH	1N4004FH	1N4005FH	1N4006FH	1N4007FH
Marking	A1	A2	A3	A4	A5	A6	A7

General Purpose Silicon Rectifiers

1N4001FH ~ 1N4007FH

■ Typical Characteristics

Fig.1 Forward Current Derating Curve

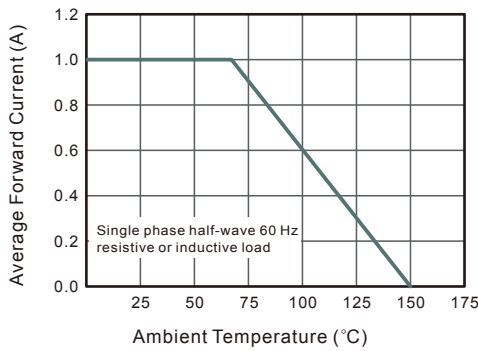

Fig.2 Typical Instaneous Reverse Characteristics

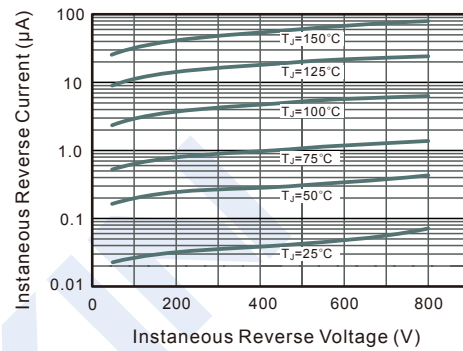

Fig.3 Typical Forward Characteristic

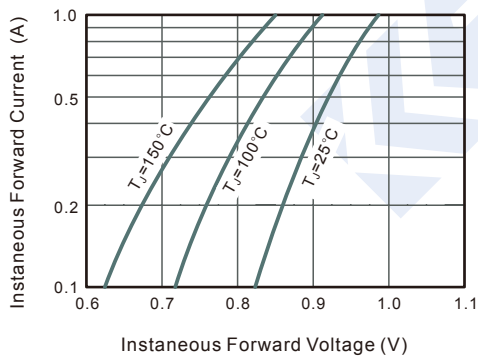
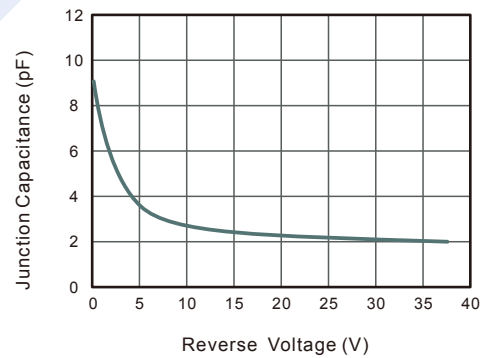

Fig.4 Typical Junction Capacitance



General Purpose Silicon Rectifiers

1N4001FH ~ 1N4007FH

■ Typical Application

Plastic surface mounted package; 2 leads

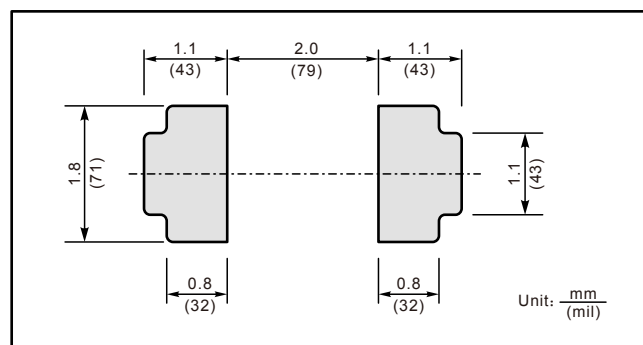
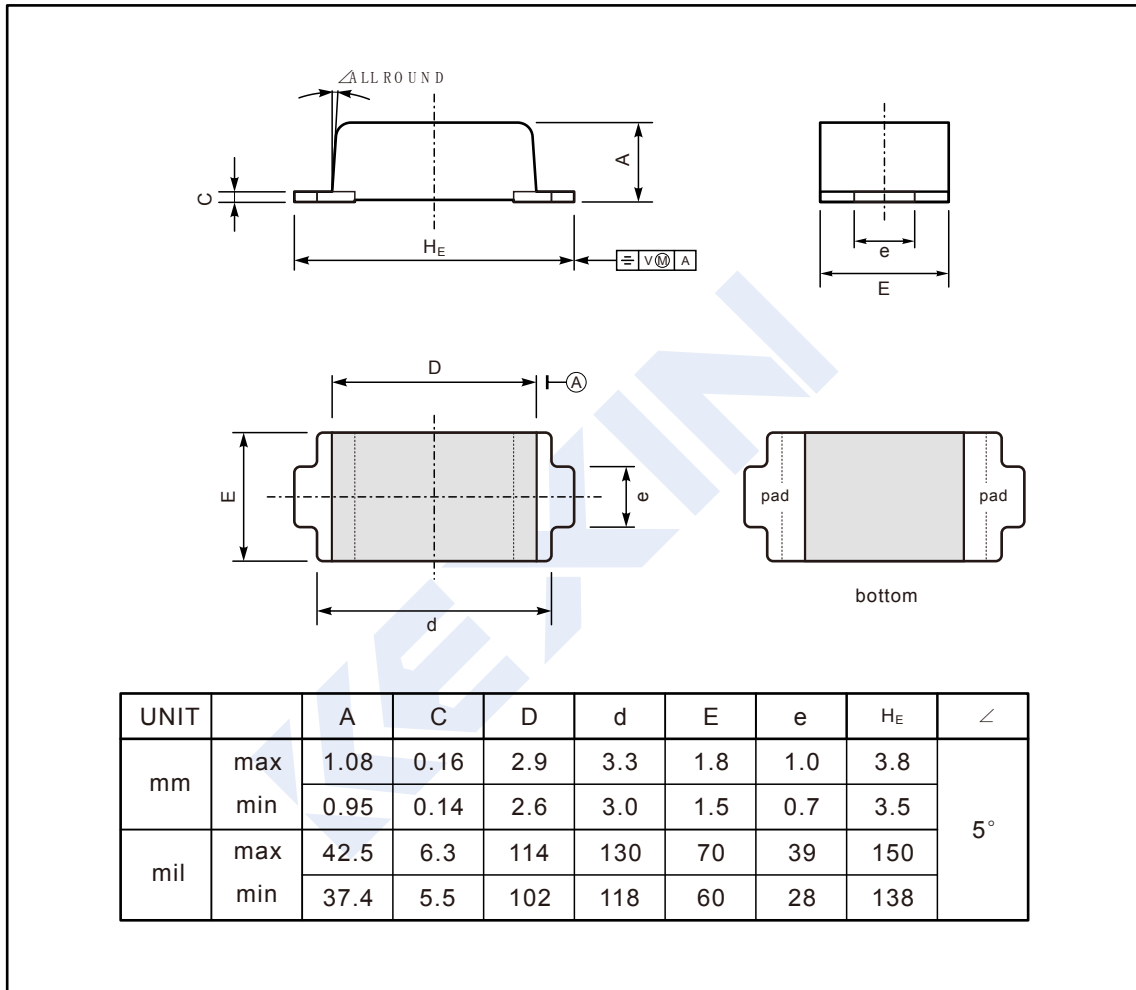

General Purpose Silicon Rectifiers

1N4001FH ~ 1N4007FH

■ Typical Application

Recommended condition of flow soldering

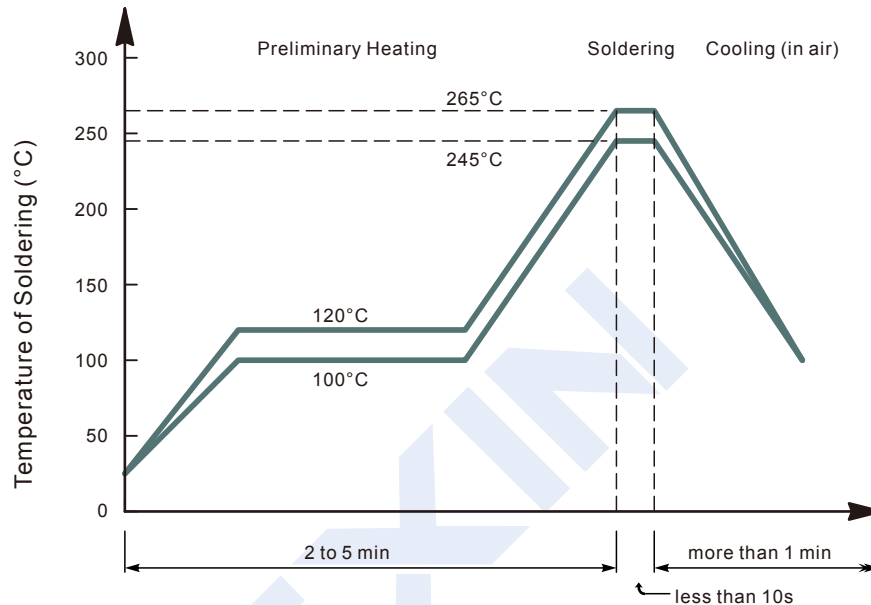

Recommended condition of reflow soldering

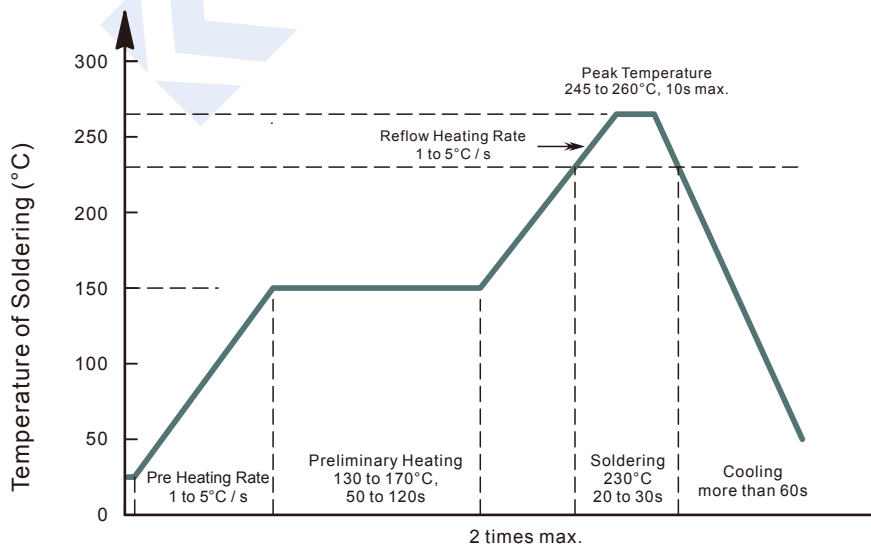

Recommended peak temperature is over 245 °C. If peak temperature is below 245 °C, you may adjust the following parameters; time length of peak temperature (longer), time length of soldering (longer), thickness of solder paste (thicker)