

1N4148WS

Silicon Epitaxial Planar Switching Diode

Features

- SC-76 package
- Fast switching
- These diodes are also available in other case style including the DO-35 case with the type designation 1N4148, the MiniMELF case with the type designation LL4148 and the MicroMELF case with the type designation MCL4148.

PINNING

PIN	DESCRIPTION
1	Cathode
2	Anode

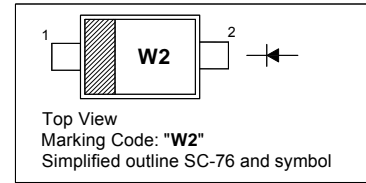

Absolute Maximum Ratings ($T_a = 25\text{ }^\circ\text{C}$)

Parameter	Symbol	Value	Unit
Peak Reverse Voltage	V_{RM}	100	V
Reverse Voltage	V_R	75	V
Average Rectified Forward Current	$I_{F(AV)}$	150	mA
Surge Forward Current	I_{FSM}	2 1	A
Power Dissipation	P_{tot}	200	mW
Thermal Resistance from Junction to Ambient Air	$R_{\theta JA}$	625	$^\circ\text{C/W}$
Junction Temperature	T_j	150	$^\circ\text{C}$
Storage Temperature Range	T_{stg}	- 65 to + 150	$^\circ\text{C}$

Characteristics at $T_a = 25\text{ }^\circ\text{C}$

Parameter	Symbol	Min.	Max.	Unit
Reverse Breakdown Voltage at $I_R = 1\text{ }\mu\text{A}$	$V_{(BR)R}$	75	-	V
Forward Voltage at $I_F = 1\text{ mA}$ at $I_F = 10\text{ mA}$ at $I_F = 50\text{ mA}$ at $I_F = 150\text{ mA}$	V_F	- - - -	0.715 0.855 1 1.25	V
Peak Reverse Current at $V_R = 75\text{ V}$ at $V_R = 20\text{ V}$ at $V_R = 75\text{ V}, T_J = 150\text{ }^\circ\text{C}$ at $V_R = 25\text{ V}, T_J = 150\text{ }^\circ\text{C}$	I_R	- - - -	1 25 50 30	μA nA μA μA
Total Capacitance at $V_R = 0\text{ V}, f = 1\text{ MHz}$	C_T	-	2	pF
Reverse Recovery Time at $I_{rr} = 0.1 \times I_R, I_F = I_R = 10\text{ mA}, R_L = 100\text{ }\Omega$	t_{rr}	-	4	ns



SEMTECH ELECTRONICS LTD.



ISO/TS 16949 : 2009
Certificate No. 160713000

ISO14001 : 2004
Certificate No. 7116

ISO 9001 : 2008
Certificate No. 90719410

BS-OHSAS 18001 : 2007
Certificate No. 7116

IECQ QC 080000
Certificate No. PRC-HSPM-1485-1

Dated: 21/04/2016 Rev: 04

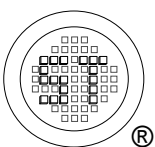
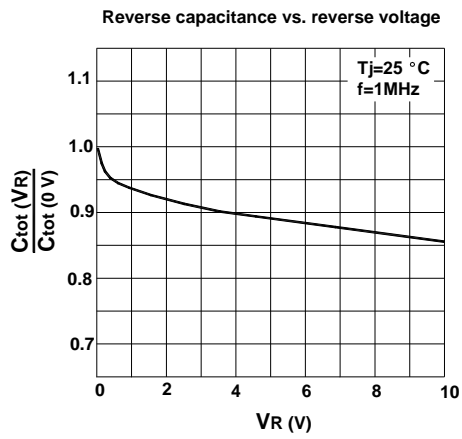
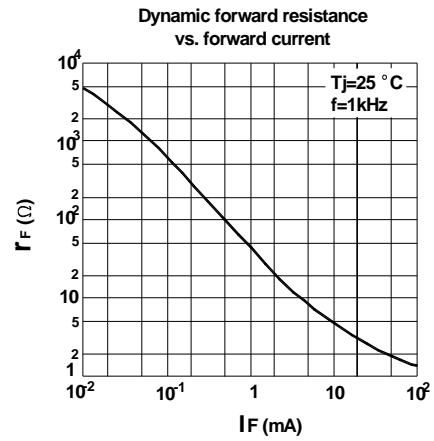
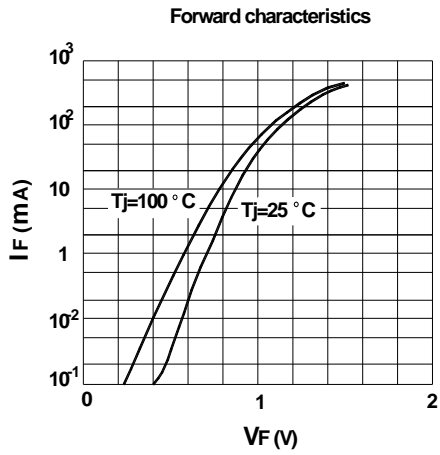

SEMTECH ELECTRONICS LTD.



1N4148WS

PACKAGE OUTLINE

Plastic surface mounted package; 2 leads

SC-76

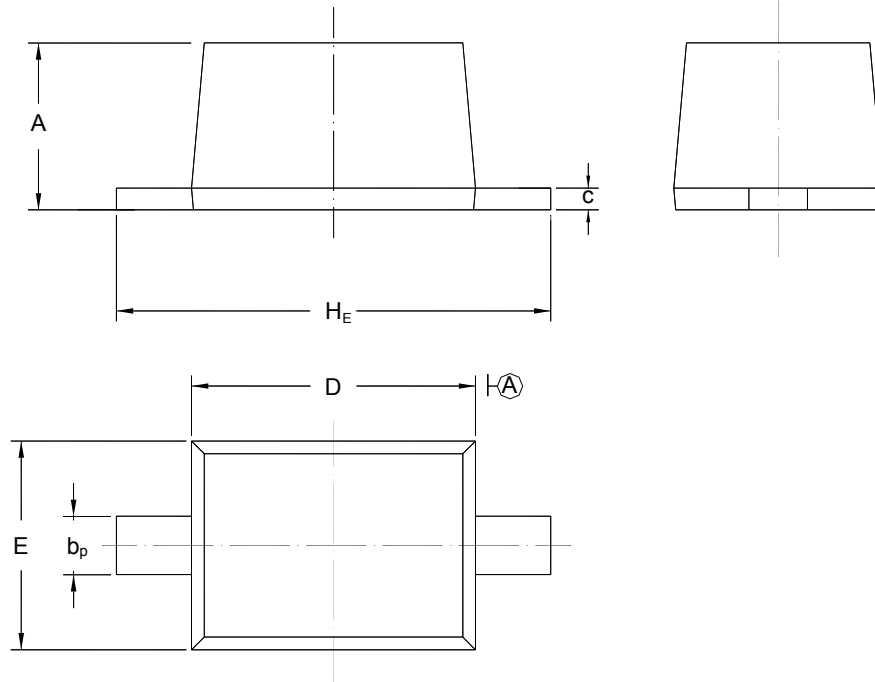

UNIT	A	b_p	C	D	E	H_E
mm	1.10 0.80	0.40 0.25	0.15 0.10	1.80 1.60	1.35 1.15	2.80 2.30

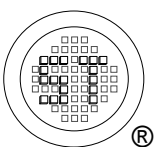

SEMTECH ELECTRONICS LTD.



ISO/TS 16949 : 2009
Certificate No. 160713000



ISO14001 : 2004
Certificate No. 7116



ISO 9001 : 2008
Certificate No. 50719410



BS-OHSAS 18001 : 2007
Certificate No. 7116



IECQ QC 080000
Certificate No. PRC-18P16-1485-1

Dated: 21/04/2016 Rev: 04